



**maggi**

Italian Woodworking Machinery

**RANGES** Flex / Industrial / Router

# Evolution

800/1000/1200

**CNC BORING MACHINES**  
simple

[maggi-technology.com](http://maggi-technology.com)

# Evolution

800/1000/1200

Execution of all operations in one working cycle

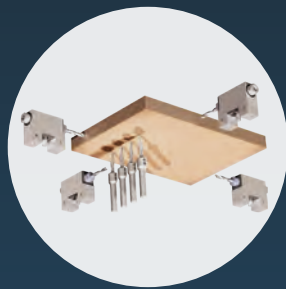

programmirt

RANGES

Flex / Industrial / Router

Wooden panels can be drilled over the whole surface with any spindle

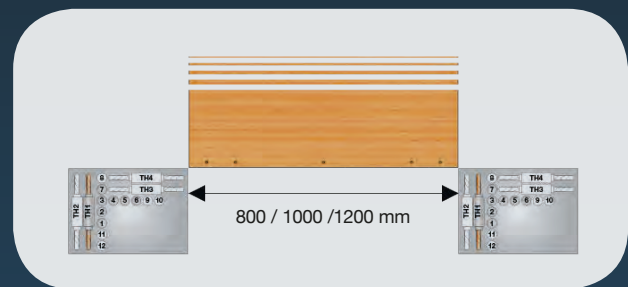

ing is simple

# Programming is simple

Simple to program drilling machines, expressly developed for beginners at CNC (Soft-approach)

- 1 WINDOWS OPERATIVE SYSTEM
- 2 PARAMETRIC PROGRAMMING
- 3 MACROS TO AUTOMATE YOUR TASKS
- 4 HELP ON LINE

## 1-Click programming

**maggi** Software is equipped with MACROS (LIGHT) to perform the most common working tasks; more MACROS (PRO) can be added as options to perform more complex milling tasks. Our technicians can develop customised MACRO (CUSTOM) on demand.

### MACRO LIGHT



### MACRO PRO



### MACRO CUSTOM



sim

# Customer service



## ON-LINE ASSISTANCE

At **maggi** Service skilled technicians and software experts are always at disposal for on-line assistance, technical advice and training courses.



## EASY-SPARE PARTS

With a QR code on board the spare-part identification gets easy and fast.



## SPARE-PART SHIPMENT IN 24Hrs

Spare-part identification and shipment within 24 hrs.

# Optionals



## 3D CABINET

3-D Software to design complete pieces of furniture, including accessories, and automatically generate:

- working programs suited for immediate delivery to the CNC and straight execution;
- lists of panels and dimensions;
- list of necessary hardware;
- quotations;
- bar-codes.



## BARCODE READER

With a bar-code reader the upload of a working program is extremely fast.



## OFFICE SOFTWARE

CAD/CAM-software additional licence for PC programming.



## POST-PROCESSOR SPECIFICATIONS

Specifications for importing CAD drawings from other CNC Softwares.



## TOOLBOX

All you need for a good start! A selection of several tools by our technicians.

able

# Evolution Flex



800 / 1000 / 1200

Simple to program CNC borers with modular boring heads to meet your specific working needs.

- MODULAR BORING HEAD
- SIMPLE PROGRAMMING AND INTUITIVE INTERFACE
- STRONG AND STABLE STRUCTURE

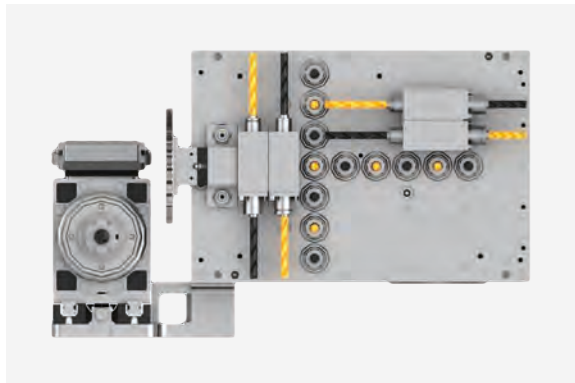

## MODULAR BORING HEAD

- 7 vertical spindles
- 1 horizontal spindle for drilling back/forth (TH1)

### Configurable options:

- 5 vertical spindles ( a total of 12 vertical spindles)
- Horizontal spindle ( TH2) for drilling back/ forth. In combination with TH1 it allows the operator to drill the two matching holes in one shot.
- Horizontal spindles (TH3) and (TH4) for the processing of 4th and 5th side
- Blade unit for grooving
- Routing unit

## SIMPLE PROGRAMMING AND INTUITIVE INTERFACE

**maggi** Software is very simple to program and has an extremely intuitive interface, which make it widely accessible to all user categories for fast and easy learning.

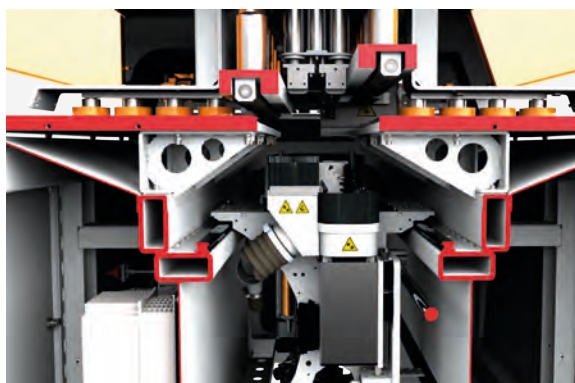

## STRONG AND STABLE STRUCTURE

The whole structure is tested in industrial domain and built to withstand intense work over the time.

# Data sheet



## Evolution Flex

### STANDARD

### OPTIONAL

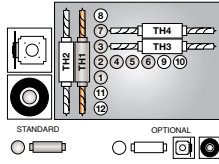

#### Boring-Head Equipment

7 vertical spindles;  
1 horiz. spindle TH1 for drilling back/forth;  
1 controlled laser reference.

Up to 5 additional vertical spindles;  
1 horiz. spindle TH2 for drilling back/forth;  
1 horiz. spindle TH3 for side drilling;  
1 horiz. spindle TH4 for side drilling;  
1 blade unit;  
1 independent routing unit with collet chuck type ER 25  
max. diam. 16mm, kW 2,2 / 18.000 rpm.



#### Panel Dimensions

	MIN (mm)	MAX (mm)
X	300	∞*
Y	75	800 / 1.000 / 1.200
Z	8	60*

	MIN (mm)	MAX (mm)
X	300	∞*
Y	75	800 / 1.000 / 1.200
Z	8	60*



#### Working Field with any spindle

X	∞
Y	800 mm / 1.000 mm / 1.200 mm

X	∞
Y	800 mm / 1.000 mm / 1.200 mm

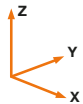

#### Axis Speed

	m/MIN (mm)
X	70
Y	70
Z	25

	m/MIN (mm)
X	70
Y	70
Z	25

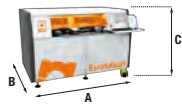

#### Dimensions and Weight

A	2.525 mm
B	1.330 mm
C	1.560 mm
W	1.400 / 1.450 / 1.500 Kg

A	2.525 mm
B	1.330 mm
C	1.560 mm
W	1.400 / 1.450 / 1.500 Kg



#### Air Pressure

6/8 Bar

6/8 Bar



#### Dust-Collection Nozzle

80mm diam. nozzle to connect the machine to a dust collector.



#### Airflow

Q. = 750 m<sup>3</sup> /h

Q. = 750 m<sup>3</sup> /h

\*also depending on the weight and dimensions of the wooden panel





# Evolution Industrial



1000 / 1200

The competitive solution for high-productivity.

- FRONT IDLE-ROLLER TABLE
- AUTOMATIC SIDE ALIGNER
- LASER REFERENCE

A winning combination of 3 simple devices that makes the loading and positioning of all types of panels very easy and fast for the operator to perform, thus, considerably increasing the productivity.



## FOLDING IDLE-ROLLER TABLE (FRONT 500mm x 750mm)

It is included in the standard equipment of "Evolution Industrial" machines; it makes easier and more comfortable for the operator to load and unload any type of panels.

## SIDE ALIGNER

The motorized side aligner automatically leans the working panels against the reference stop. This device makes the positioning extremely fast and precise.

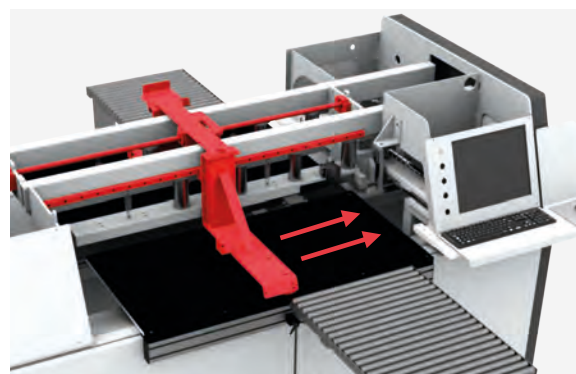

## LASER REFERENCE FOR PERFECT PANEL MATCHING

Highly-accurate laser device to detect the exact panel dimensions and readjust the data into the working program accordingly.





# Data sheet

## Evolution Industrial

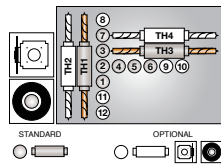

### Boring-Head Equipment

#### STANDARD

7 vertical spindles;  
1 horiz. spindle TH1 for drilling back/forth;  
1 horiz. spindle TH3 for side drilling;  
1 controlled laser reference.

#### OPTIONAL

Up to 5 additional vertical spindles;  
1 horiz. spindle TH2 for drilling back/forth;  
1 horiz. spindle TH4 for side drilling;  
1 blade unit;  
1 independent routing unit, two options available:  
- Router with collet chuck type ER 25 max. diam. 16mm, kW 2,2 / 18.000 rpm;  
- Router with collect chuck type ER 32 max. diam. 16 mm, kW 4,5 / 18.00 rpm.



### Motorized Side-Aligner

1 motorized side-aligner.



### Panel Dimensions

	MIN (mm)	MAX (mm)
X	300	∞*
Y	75	1.000 / 1.200
Z	8	60*

	MIN (mm)	MAX (mm)
X	300	∞*
Y	75	1.000 / 1.200
Z	8	60*



### Working Field with any spindle

X	∞
Y	1.000 mm / 1.200 mm

X	∞
Y	1.000 mm / 1.200 mm

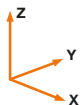

### Axis Speed

	m/MIN (mm)
X	70
Y	70
Z	25

	m/MIN (mm)
X	70
Y	70
Z	25



### Dimensions and Weight

A	2.525 mm
B	1.330 mm
C	1.560 mm
W	1.400 / 1.450 / 1.500 Kg

A	2.525 mm
B	1.330 mm
C	1.560 mm
W	1.400 / 1.450 / 1.500 Kg



### Air Pressure

6/8 Bar

6/8 Bar



### Dust-Collection Nozzle

80mm diam. nozzle to connect the machine to a dust collector.



### Airflow

Q. = 750 m3 /h

Q. = 750 m3 /h

\*also depending on the weight and dimensions of the wooden panel



# Evolution Router



800 / 1000 / 1200

Well-dimensioned boring machines designed for heavy-duty milling operations.

- STEEL MADE **IRONMAN** STRUCTURE
- ENHANCED MILLING UNIT 4,5 KW
- STRENGTHENED CLAMPING UNIT AND SLIDING BORING-HEAD SYSTEM



## ENHANCED MILLING UNIT

The UNIQUE structure of the milling unit sliding on four blocks and rolling guides and the enhanced 4,5 kW motor ensure high stability and all the power you need.

## STRENGTHENED CLAMPING UNIT AND SLIDING BORING-HEAD SYSTEM

The strengthened clamping unit and the strong boring-head, sliding on blocks and rolling guides, make these boring machines best suited to handle big and heavy wooden panels up to a maximum weight of 70 Kg and always ensure the highest accuracy of the milling operations.



## IRONMAN STRUCTURE

The **IRONMAN** structure, tested in industrial domain and built to withstand intense work and heavy-duty tasks, is reinforced with high-resistance steel frame-connections to ensure the highest stability during the working process. The whole structure is part of our in-house highly-accurate machining process and made of 8 mm thickness, electro-welded steel and is 1.500 Kg weight.

# Data sheet



## Evolution Router

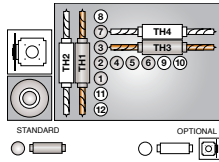

### Boring-Head Equipment

#### STANDARD

7 vertical spindles;  
1 horiz. spindle TH1 for drilling back/forth;  
1 horiz. spindle TH3 for side drilling;  
1 routing unit with manual quick-change system HSK 40,  
max. diam. 16 mm kW 4,5 / 18.000 rpm;  
1 controlled laser reference.

#### OPTIONAL

Up to 5 additional vertical spindles;  
1 horiz. spindle TH2 for drilling back/forth;  
1 horiz. spindle TH4 for side drilling;  
1 blade unit;  
1 independent routing unit with two options available:  
1 router with manual quick-change system HSK 40,  
max. diam 16 mm kW 3,3 / 18.000 rpm;  
1 router with collet chuck type ER 32  
max. diam. 16 mm, kW 3,3 / 18.000 rpm;  
1 automatic tool-changer - 4 positions;\*\*  
1 adaptor for CLAMEX.\*\*



### Panel Dimensions

	MIN (mm)	MAX (mm)
X	300	∞*
Y	75	800 / 1.000 / 1.200
Z	8	60*

	MIN (mm)	MAX (mm)
X	300	∞*
Y	75	800 / 1.000 / 1.200
Z	8	60*



### Working Field with any spindle

X	∞
Y	800 mm / 1.000 mm / 1.200 mm

X	∞
Y	800 mm / 1.000 mm / 1.200 mm

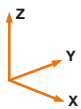

### Axis Speed

	m/MIN (mm)
X	70
Y	70
Z	25

	m/MIN (mm)
X	70
Y	70
Z	25

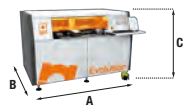

### Dimensions and Weight

A	2.525 mm
B	1.330 mm
C	1.560 mm
W	1.400 / 1.450 / 1.500 Kg

A	2.525 mm
B	1.330 mm
C	1.560 mm
W	1.400 / 1.450 / 1.500 Kg



### Air Pressure

6/8 Bar

6/8 Bar



### Dust-Collection Nozzle

80mm diam. nozzle to connect the machine to a dust collector.



### Airflow

Q. = 750 m<sup>3</sup> /h

Q. = 750 m<sup>3</sup> /h

\*also depending on the weight and dimensions of the wooden panel

\*\*not available yet and coming soon



# Simplicity is the Ultimate Sophistication

Leonardo da Vinci



## **maggi Service**

Tel. +39 0571 635 477

Mob. +39 335 284 751

Mail: [service@maggi-technology.com](mailto:service@maggi-technology.com)

Skype: [service.maggitechnology](https://www.skype.com/name/username/service.maggitechnology)



## **maggi Technology**

Via delle Regioni, 297 - 50053 Certaldo (FI), Italy  
T. +39 0571 63541 - C.F. e P.IVA IT01264750520

[maggi-technology.com](http://maggi-technology.com)